

Installation/Care/Use Manual

Soft Sides™ Refrigerated Fountain with FLEXI-GUARD®

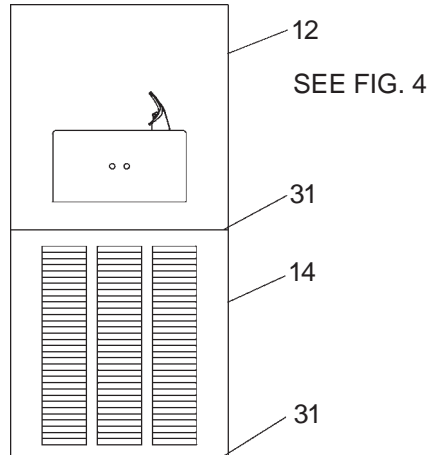

Installer

To assure you install this model easily and correctly, PLEASE READ THESE SIMPLE INSTRUCTIONS BEFORE STARTING THE INSTALLATION. CHECK YOUR INSTALLATION FOR COMPLIANCE WITH PLUMBING, ELECTRICAL AND OTHER APPLICABLE CODES. After installation, leave these instructions inside the fountain for future reference.

IMPORTANT

ALL SERVICE TO BE PERFORMED BY AN AUTHORIZED SERVICE PERSON

IMPORTANT! INSTALLER PLEASE NOTE.

THE GROUNDING OF ELECTRICAL EQUIPMENT SUCH AS TELEPHONE, COMPUTERS, ETC. TO WATER LINES IS A COMMON PROCEDURE. THIS GROUNDING MAY BE IN THE BUILDING OR MAY OCCUR AWAY FROM THE BUILDING. THIS GROUNDING CAN CAUSE ELECTRICAL FEEDBACK INTO A FOUNTAIN, CREATING AN ELECTROLYSIS WHICH CAUSES A METALLIC TASTE OR AN INCREASE IN THE METAL CONTENT OF THE WATER. THIS CONDITION IS AVOIDABLE BY USING THE PROPER MATERIALS AS INDICATED. ANY DRAIN FITTINGS PROVIDED BY THE INSTALLER SHOULD BE MADE OF PLASTIC TO ELECTRICALLY ISOLATE THE FOUNTAIN FROM THE BUILDING PLUMBING SYSTEM.

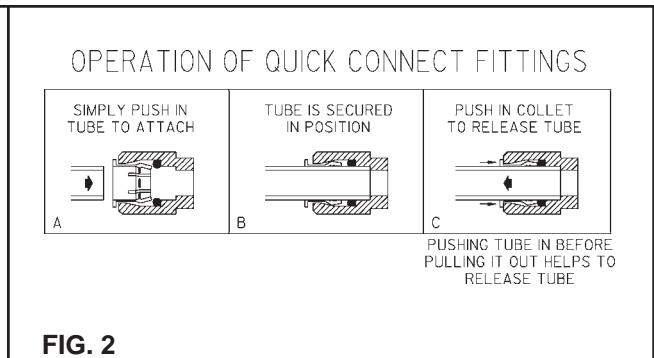
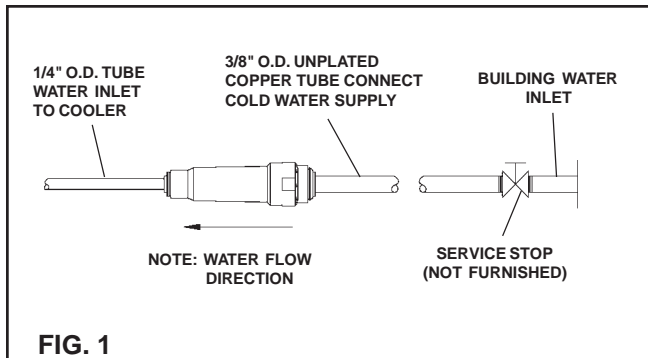

ERO8C ROUGH-IN

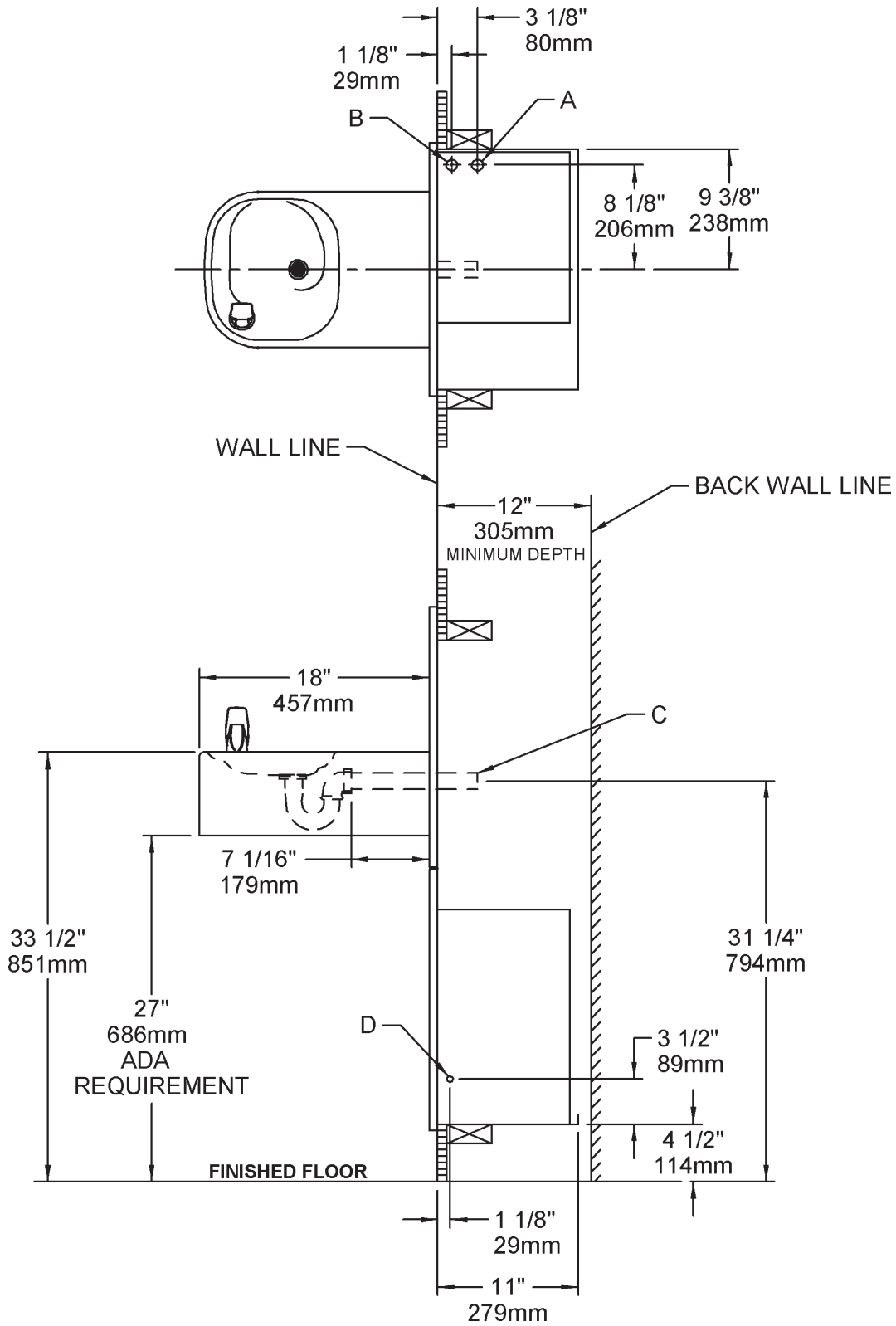

LEGEND

- A = 1/4" O.D. TUBE CONNECT (CHILLER WATER OUTLET)
- B = 3/8" O.D. TUBE CONNECT (CHILLER WATER INLET) SHUT OFF VALVE BY OTHERS
- C = 1-1/4" TRAP FURNISHED
- D = ELECTRICAL INLET

FIG. 3

INSTALLATION INSTRUCTIONS

1. Install mounting frame. See mounting frame instructions.
2. Install remote chiller. Remove front panel of chiller. Slide chiller onto the shelf and position it to the left within the guides on the shelf.
3. Attach solenoid valve assy to the underside of cross member of mounting frame. See Figure 7.
4. Make water supply connections. Install a shut-off valve and union connection to building water supply (valve and union not provided). Turn on the water supply and flush the line thoroughly.
5. Make connection between remote chiller and building supply line. Install the strainer on the chiller inlet tube. Install a 3/8" O.D. unplated copper water line between the valve and the cooler. Remove all burrs from the outside of the water line. Insert the 3/8" water line into the inlet side of the strainer by pushing it in until it reaches a positive stop, approximately 3/4" (19mm). See Figures 2 and 5. **DO NOT SOLDER TUBES INSERTED INTO THE STRAINER AS DAMAGE TO THE O-RINGS MAY RESULT.** Install the 1/4" x 1/4" union (provided) on the chiller outlet tube.
6. Make connection between remote chiller and solenoid valve assy. Insert end of 1/4" O.D. poly tubing (provided) into union on chiller outlet and the other end into straight fitting on solenoid valve assy.
7. Hang the upper panel on the mounting frame hanger. Align holes in the panel with holes in the mounting frame. Be sure that panel is engaged with hanger at top of frame before releasing it.
8. Install fountain. Remove bottom cover plate on underside of fountain and save the screws. Mount the fountain to the upper panel and the wall frame with (4) 5/16" x 3/4" (19mm) long bolts and nuts (provided). Tighten securely.
9. Connect solenoid valve assy and regulator holder in fountain by inserting 1/4" O.D. poly tubing (provided).
10. Remove elbow from end of p-trap and attach it to drain tube. Re-attach elbow to p-trap and cut waste tube to required length using plumbing hardware and trap as a guide.
11. Connect power cord of sensor to solenoid valve by running it through the back panel and connecting it as shown in Fig. 8. Connectors may be connected to either terminal on solenoid valve. Attach ground wire to solenoid valve bracket with green ground screw.
12. Turn on water supply. Release air from tank by interrupting infrared beam; steady stream of water assures all air is removed. The sensor has a 30 second maximum **ON** time. It may be necessary to step away from beam a few times to allow chiller tank to refill. Check for leaks.
13. These products are designed to operate on 20-105 PSIG supply line pressure. If inlet pressure is above 105 PSIG, a pressure regulator must be installed in the supply line. Any damage caused by reason of connecting these products to supply line pressures lower than 20 PSIG or higher than 105 PSIG is not covered by warranty.
14. Make electrical connections to chiller. See chiller instructions.
15. Check stream height from bubbler. Stream height is factory set at 35 PSI. If supply pressure varies greatly from this, remove item 11 (bottom cover plate) and adjust the screw on the regulator (item 7). Clockwise adjustment will raise stream height and counter-clockwise will lower stream height. For best adjustment stream height should hit basin approximately 6-1/2" (165mm) from the bubbler.
16. Mount lower panel. Loosen the (2) #10-24 x 5/8" (16mm) screws at frame bottom lip. Slide upper tongue of lower panel under lower edge of already installed upper panel. Tighten previously loosened screws securely.
17. Replace bottom cover plate to fountain basin using screws provided. Tighten securely.

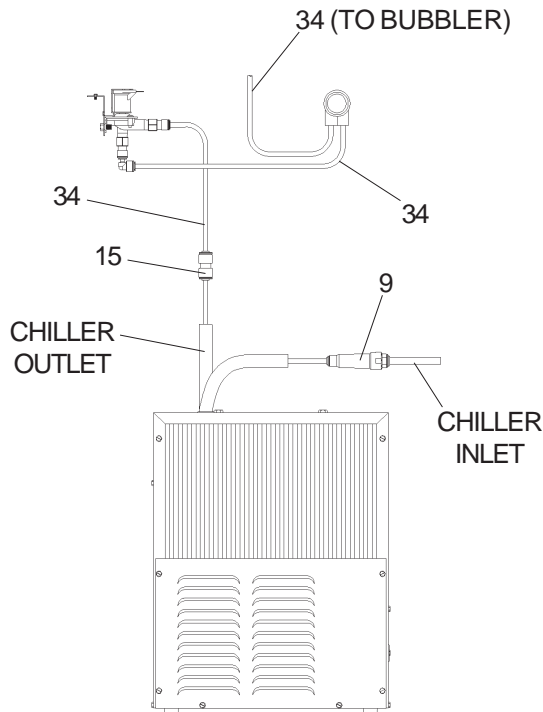

FIG. 5

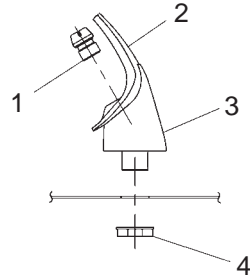

FIG. 4

NOTE: WHEN INSTALLING REPLACEMENT BUBBLER AND PEDESTAL, TIGHTEN NUT (ITEM 4) ONLY TO HOLD PARTS SNUG IN POSITION. **DO NOT OVER TIGHTEN.**

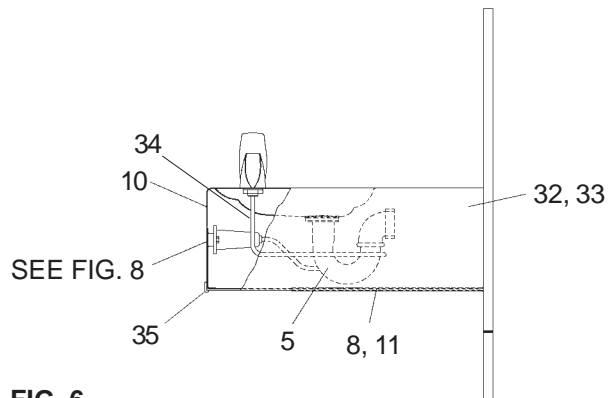

FIG. 6

PARTS LIST		
ITEM NO.	PART NO.	DESCRIPTION
1	A54874	Orifice Assy
2	56011C	Housing Assy
3	55997C	Pedestal
4	75580C	Bubbler Locknut
5	LK464	Drain
6	50986C	Regulator Holder
7	61313C	Regulator
8	112627543890	Screw - #10-24 X .50 PHTC
9	55996C	Strainer
10	27623C	Fountain Body
11	55006665	Bottom Cover Plate
12	26837C	Back Panel
13	40045C	Hex Nut
14	26833C	Lower Panel
15	70683C	Union-1/4 X 1/4
16	22525C	Regulator Mounting Bracket
17	22526C	Solenoid Mounting Bracket
18	27240C	Sensor Support Bracket
19	31272C	Solenoid Valve Assy
20	31376C	Power Cord
21	31384C	Sensor - Clear
22	38417001	Screw - #8-18 X .37 HHSM
23	56082C	Nut - Regulator
24	70016C	Hex Nut #10-32
25	50203C	Strain Relief
26	51409C	Spacer - 1/2 X .44
27	70208C	Screw - #10-24 X .38 PHTC
28	70256C	Screw - 1/4-20 X .38 HHTC
29	70817C	Elbow - 1/4 X 1/4
30	75507C	Fitting - 1/4 NPTF X 1/4 O.D.
31	111008343890	Screw - #10-24 X .62 HHMS
32	111577243890	Screw - 5/16-18 X .75
33	111577343890	Hex Nut - 5/16-18
34	56092C	Poly Tubing (Cut To Length)
35	56280C	Edge Trim

TROUBLE SHOOTING AND MAINTENANCE

- Orifice Assy:** Minerals deposits on orifice can cause water flow to spurt or not regulate. Mineral deposits may be removed from the orifice with a small round file not over 1/8" diameter or a small diameter wire.
CAUTION: Do not file or cut orifice materials.
- Stream Regulator:** If orifice is free of material deposits regulate water flow according to instructions on page 3.
- Sensor Control:** The sensor has a 2 second delay time. If sensor fails to operate valve mechanism or operates erratically, check the following:
 - Ensure there are no obstructions within a 40 inch radius from the front of fountain.
 - Check wire connections at the solenoid valve and at the sensor.
CAUTION: Make sure unit is unplugged before checking any wiring.
 - Ensure proper operation of solenoid valve. If there is an audible clicking sound yet no water flows, look for an obstruction in the valve itself or elsewhere in the water supply line.
WARNING: Do not expose sensor to direct sunlight.
- Sensor Range Adjustment:** The electronic sensor used in this fountain is factory pre-set for a "visual" range of 36 inches. If actual range varies greatly from this, or a different setting is desired, follow the range adjustment procedure below:
 - Remove bottom cover of fountain.
 - Remove sensor by removing washers and nuts that secure sensor on studs.
 - Locate range adjustment screw between the red lenses of the sensor, then with a small tip screwdriver, rotate the range adjusting screw clockwise to increase range or counter-clockwise to decrease range. 1/4 turn of screw is equal to approximately 12 - 18 inches of range.
CAUTION: Complete range of sensor (24 - 46 inches) is only one turn of the adjusting screw.
 - Remount sensor on studs and replace bottom cover.

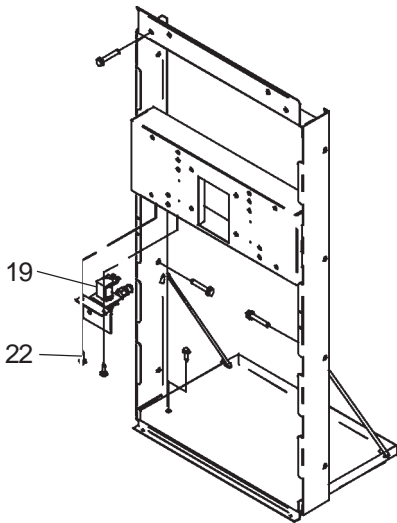

FIG. 7

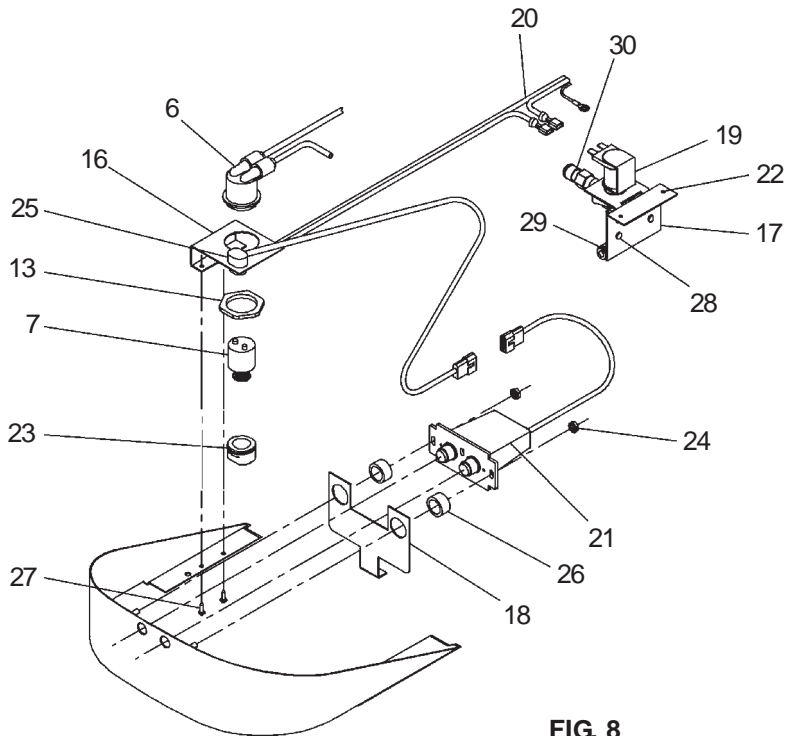

FIG. 8

REPAIR SERVICE INFORMATION TOLL FREE NUMBER 1.800.260.6640
 FOR PARTS, CONTACT YOUR LOCAL DISTRIBUTOR OR CALL 1.800.323.0620
 ELKAY MANUFACTURING COMPANY • 2222 CAMDEN COURT • OAK BROOK, IL 60523 • 630.574.8484