

Halsey Taylor Owners Manual

Model 4595

Pedestal Barrier Free Stone Fountain

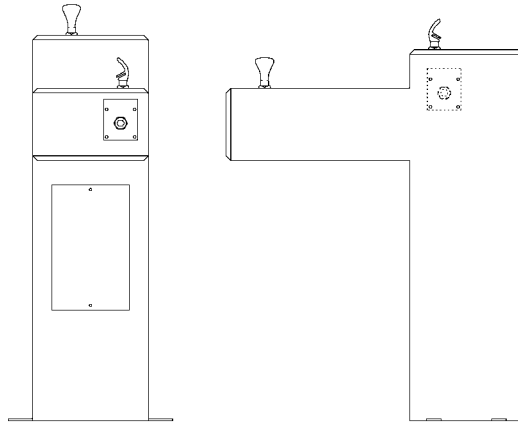

INSTALLER

To assure you install your Halsey Taylor Fountain models easily and correctly, PLEASE READ THESE SIMPLE INSTRUCTIONS BEFORE STARTING THE INSTALLATION. CHECK YOUR INSTALLATION FOR COMPLIANCE WITH PLUMBING, ELECTRICAL, AND OTHER APPLICABLE CODES. After installation, leave these instructions with the Fountain for future reference.

IMPORTANT

ALL SERVICE TO BE PERFORMED BY AN AUTHORIZED SERVICE PERSON

IMPORTANT! INSTALLER PLEASE NOTE.

THE GROUNDING OF ELECTRICAL EQUIPMENT SUCH AS TELEPHONE, COMPUTERS, ETC. TO WATER LINES IS A COMMON PROCEDURE. THIS GROUNDING MAY BE IN THE BUILDING OR MAY OCCUR AWAY FROM THE BUILDING. THIS GROUNDING CAN CAUSE ELECTRICAL FEEDBACK INTO A FOUNTAIN, CREATING AN ELECTROLYSIS WHICH CAUSES A METALLIC TASTE OR AN INCREASE IN THE METAL CONTENT OF THE WATER. THIS CONDITION IS AVOIDABLE BY USING THE PROPER MATERIALS AS INDICATED. ANY DRAIN FITTINGS PROVIDED BY THE INSTALLER SHOULD BE MADE OF PLASTIC TO ELECTRICALLY ISOLATE THE FOUNTAIN FROM THE BUILDING PLUMBING SYSTEM.

General Installation Tips

1. Water supply 3/8" O.D. unplated copper tube. Waste 1-1/4" IPS. Contractor to supply waste trap and service stop valve in accordance with local code.
2. Connecting lines to be made of unplated copper and should be thoroughly flushed to remove all foreign matter before being connected to fountain. This fountain is manufactured in such a manner that it does not in any way cause taste, odor, color, or sediment problems.
3. Connect fountain to supply line with a shut-off valve and install a 3/8" unplated copper water line between the valve and the cooler. Remove any burrs from outside of water line. Push the tubes straight into the fittings until they reach a positive stop, approximately 3/4" (See Fig. 6). **DO NOT SOLDER TUBES INSERTED INTO THE STRAINER AS DAMAGE TO THE O-RINGS MAY RESULT.**
4. These products are designed to operate on 20 psig to 105 psig supply line pressure. If inlet pressure is above 105 psig, a pressure regulator must be installed in the supply line. Any damage caused by reason of connecting this product to supply line pressures lower than 20 psig or higher than 105 psig is not covered by warranty.

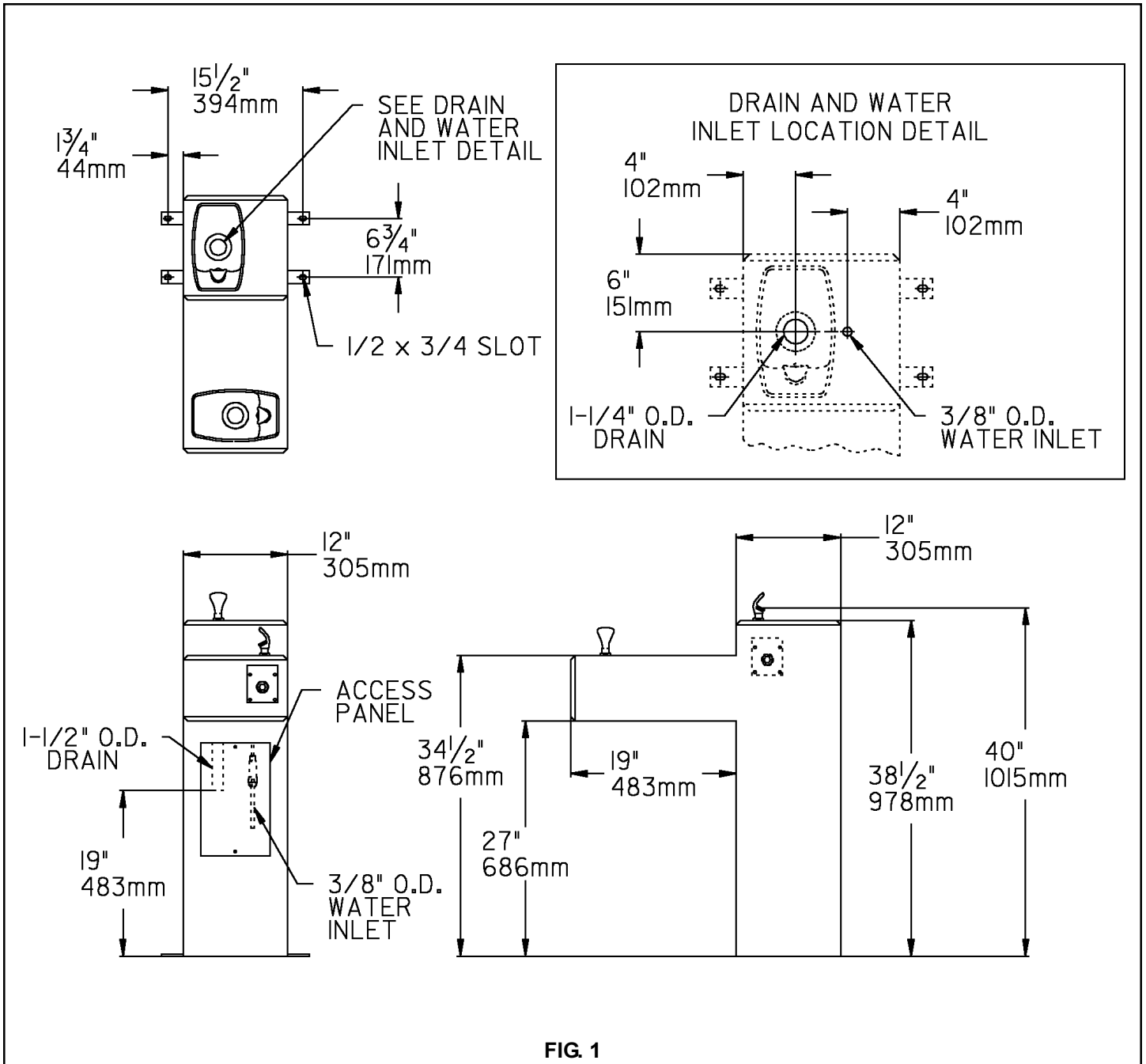

FIG. 1

Installation Instructions

1. This fountain is to be mounted on a smooth, flat, finished surface with adequate support structure. NOTE: Mounting structure must be capable of supporting 300 lb. load on fountain.
2. Refer to rough-in for plumbing.
3. Install shut-off valve on water supply. (Valve not furnished).
4. Locate and install fountain using $\frac{3}{8}$ " minimum screws or bolts. (Screws or bolts not furnished). CAUTION: This fountain is rated for inlet water pressure of 20-105 PSI. A pressure reducing regulator should be used if the inlet water supply exceeds 105 PSI.
5. Connect water supply and fountain drain. Water connection and drain must comply with local codes.
6. Turn on water supply and check all connections for leaks.

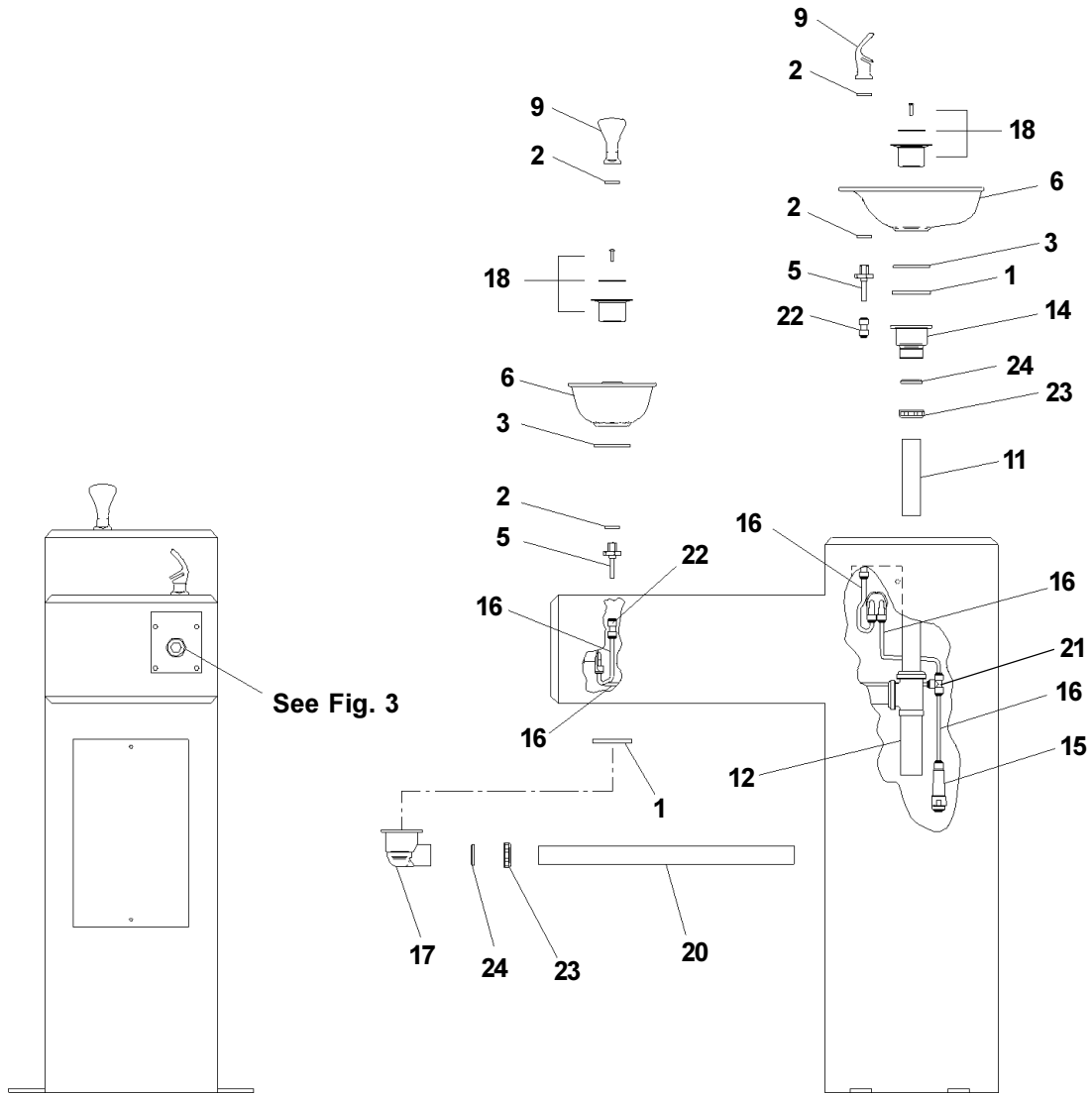

FIG. 2

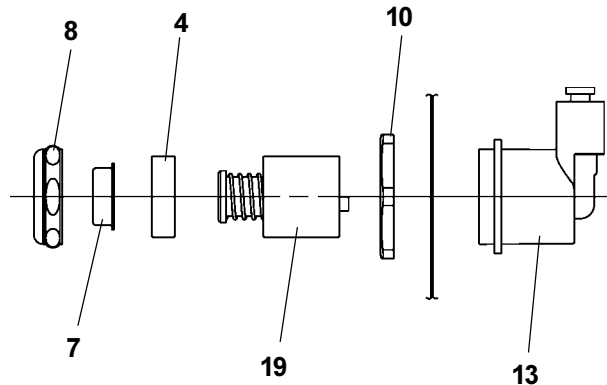
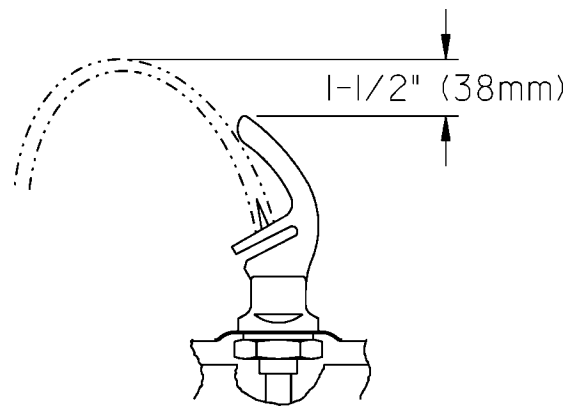

FIG. 3



STREAM HEIGHT ADJUSTMENT: Stream height is factory set at 35 PSI. If supply pressure varies greatly from this, remove items 7 and 8 (See Fig. 3) and adjust screw on item 19. Clockwise adjustment will raise stream and counter-clockwise adjustment will lower stream. For best adjustment, stream should hit basin approx. 6-1/2" from bubbler.

FIG. 4

PARTS LIST		
ITEM NO.	PARTNO.	DESCRIPTION
1	100147140560	Drain Gasket
2	100322740560	Bubbler Gasket
3	101570540560	Drain Gasket
4	15005C	Regulator Retaining Nut
5	15013C	Bubbler Tube Assy.
6	170705042830	Basin
7	40048C	Button
8	40089C	Cover Nut
9	400942308640	Bubbler
10	40169C	Hex Nut 1-5/16-20UN
11	40250C	Tailpipe 1-1/4" x 5-3/8"
12	45476C	Drain Tube
13	50986C	Regulator Holder
14	55913C	Drain Adapter
15	55996C	In-Line Strainer
16	56092C	Poly Tubing (Cut To Length)
17	56121C	Drain Elbow 1-1/4"
18	600985551640	Drain Plug Assy.
19	61313C	Regulator
20	66346C	Drain Tube
21	70682C	Tee - 1/4
22	70683C	Union - 1/4
23	75588C	Slip Joint Nut 1-1/4"
24	75589C	Gasket

TROUBLE SHOOTING AND MAINTENANCE

Orifice Assy: Mineral deposits on orifice can cause water flow to spurt or not regulate. Mineral deposits may be removed from the orifice with a small round file or small diameter wire. **CAUTION: DO NOT** file or cut orifice material.

Stream Regulator: If orifice is clean, regulate flow as in "STREAM HEIGHT ADJUSTMENT" instructions on page 3. If replacement is necessary, see parts list for correct regulator part number.

Actuation of Quick Connect Water Fittings: Fountain is provided with lead-free connectors which utilize an o-ring water seal. To remove tubing from the fitting, relieve water pressure, push in on the gray collar while pulling on the tubing (See Fig. 5). To insert tubing, push tube straight into fitting until it reaches a positive stop, approximately 3/4".

OPERATION OF QUICK CONNECT FITTINGS

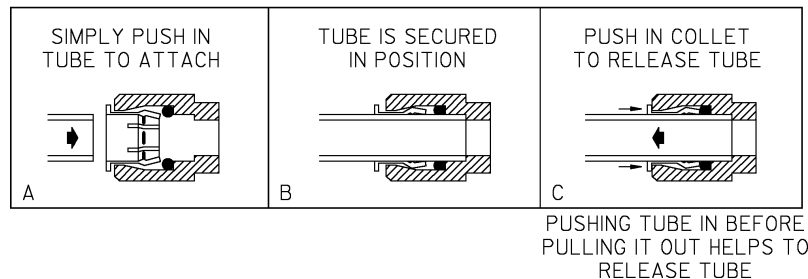

FIG. 5

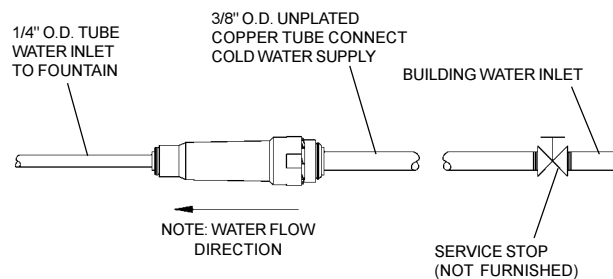

FIG. 6

Halsey Taylor
 2222 CAMDEN COURT
 OAKBROOK, IL 60523
 630.574.3500

PRINTED IN U.S.A.

FOR PARTS, CONTACT YOUR LOCAL DISTRIBUTOR OR VISIT OUR WEBSITE WWW.HALSEYTAYLOR.COM